

International Journal of Innovative Research in Science, Engineering and Technology

(An ISO 3297: 2007 Certified Organization)

Website: www.ijirset.com

Vol. 6, Issue 6, June 2017

Noise Removal Based On Discrete Wavelet Transform and Filters

Fathimuthu Joharah S¹, Shajun Nisha S²

M.Phil. (PG Scholar), Department of Computer Science, Sadakathullah Appa College, Tirunelveli, Tamilnadu, India¹

Prof & Head, PG Department of Computer Science, Sadakathullah Appa College, Tirunelveli, Tamilnadu, India²

ABSTRACT: Digital images are corrupted by noises due to various effects during image acquisition and transmission. Denoising is an important task in image processing. The medical images used for diagnosis which are acquired from Magnetic Resonance Imaging (MRI), Computed Tomography (CT), and X-ray Instruments are not noise free. Noise removal is essential in medical imaging applications in order to enhance and recover fine details that may be hidden in the data. The search for efficient image noise removal method is still a challenge for researchers. There are lots of noise removal techniques that have been developed over a period. Wavelet is gaining popularity in the area of medical image denoising due to its sparsity and multiresolution properties. The Discrete Wavelet Transform (DWT), which is based on sub-band coding is found to yield a fast computation of Wavelet Transform. This paper presents an analysis of noise removal in an MRI liver image using discrete wavelet transform at decomposition of image at level 1 and by filters. The performance of noise removal is evaluated in terms of PSNR, MSE, and ACCURACY.

KEYWORDS: DWT, PSNR, MSE, ACCURACY

I. INTRODUCTION

In digital image processing image denoising focuses on the removal of noise, which may occur in an image during its acquisition and/or transmission. The main property of a good denoising model is that it will remove noise and preserve edges. Noise removal is essential in medical imaging applications in order to enhance and recover fine details that may be hidden in the data. Medical imaging refers to the technique that is used to view the human body in order to diagnose, monitor, or treat medical conditions. MRI is one of the most common tool used in medical field for diagnosis. These images are often affected by random noise arising in the image acquisition process. Mostly noise in medical images may lead to false diagnosis and treatment of disease. Noise is a random variation of brightness or color information in images which degrades the image quality. To achieve noise reduction goal some transforms are used. Discrete Wavelet Transform is a powerful tool for noise removal. This paper presents an analysis of noise removal in an MRI liver image by applying Discrete Wavelet Transform (DWT) and performance is evaluated in terms of PSNR, MSE and ACCURACY.

II. RELATED WORKS

Denoising of different medical images like MRI, Ultrasound, X-ray, CT is performed using haar and db3 wavelets at both soft and hard threshold levels and PSNR value is calculated and it is found that db3 wavelet is more efficient than haar for removing certain level of speckle noise in the medical images and also it enhances the visual quality of the medical images[5]. An improved method of NeighShrink (proposed method) using the Stein's unbiased risk estimate (SURE) by using optimal threshold and neighbouring window size for every wavelet subband instead of using the suboptimal universal threshold and same neighbouring window size in all subbands. Experimental results conclude that

International Journal of Innovative Research in Science, Engineering and Technology

(An ISO 3297: 2007 Certified Organization)

Website: www.ijirset.com

Vol. 6, Issue 6, June 2017

NeighShrink produce good results compare to VisuShrink and SureShrink[7]. Three different wavelets Haar, Db2 & Sym4 with hard & soft thresholding have been analysed. Sym4 wavelet is most efficient among all three for removing and recognizing these characters can be very important, and removing these is important in the context of removing indirect advertisements, and for aesthetic reasons.

Our system aims at the automatic detection of text. This the gaussian noise with different variance in the medical images and also it enhances the visual quality of the medical images[2]. Wavelet transform is a mathematical technique that decomposes the signal into series of small basis function called wavelets. It allow the multiresolution analysis of image and is well localized in both time and frequency domain. As a result of wavelet transform the image is decomposed into low frequency and high frequency components. The information content of these sub images that corresponds to Horizontal, Vertical and Diagonal directions implies unique feature of an image[14]. A new technique formed by the hybridizing the thresholding technique of the image decomposed using discrete wavelet transform along with the transformation of intensity to obtain a noise free, high quality denoised image[9].

The importance of denoising algorithm is to completely remove noise as far as possible and preserve edges. There are two models linear and non linear. Generally linear models are used. The benefit of linear noise removal model is speed and drawback is they do not preserve edges in an image. Non-linear model can handle edges in a better way. The most popular non-linear image de-noising is Total Variation (TV) filter. The performance of Wiener filter after de-noising for all Speckle, Poisson and Gaussian noise is better than mean filter and median filter. The performance of the median filter after de-noising for all Salt & Pepper noise is better than Mean filter and Wiener filter[1]. Image de-noising using discrete wavelet transform is analyzed and experiments were conducted to study the suitability of different wavelet bases and also different window sizes. Among all discrete wavelet bases, coiflet performs well in image denoising. Experimental results show that modified Neighshrink gives better results than Neighshrink, Wiener filter and Visushrink[4]. Image noise is the random variation of brightness or color information in images produced by the sensor and circuitry of a scanner or digital camera. Image noise can also originate in film grain and in the unavoidable shot noise of an ideal photon detector [17].

Impulse noise removal for gray scale images using the standard median filter and its variants are analysed. Results show that tristate median filter and switching median filter exhibit visually appealing results. The other methods such as standard median filter, adaptive median filter, weighted median filter lack in preserving edges while retaining some noise components[8]. To examine various algorithms and discrete wavelet transform and understanding the concept of denoising[10].

A. Motivation and Justification:

Denoising is the process of removing noise from the image and preserve all the relevant features of the image. There are numerous techniques available for denoising purpose. The selection of denoising technique depends on the type of image and the noise present in the image.

DWT is a multiscale approximation (or) multiresolution analysis. DWT can bestow a limited directionality and it is also has an essential feature for multi-dimensional signals. DWT transform is efficient method for decomposition and it decomposes the lower coefficients to procure next level approximations and detailed coefficient. In DWT computational cost is high but after denoising Image fidelity is visually lossless. DWT gives a non-redundant and sole representation of the signals. DWT has many Properties such as Multiresolution, Sparsity, Edge clustering and Edge detection. It can capture both location and frequencies information and it also furnish the excellent locality in both frequency and time domain.

Our aim in this paper is to remove noise from an MRI liver image. Denoising improves the quality of the image so decomposition and noise removal filters are used. For decomposing the image we use DWT and for removing the noise we use mean and median filters. Then we reconstruct the image by using inverse DWT. The image quality measures help in the detection of the quality of the image. We calculate PSNR (Peak Signal to Noise Ratio), MSE (Mean Squared Error) and ACC (Accuracy) values and compare the results.

International Journal of Innovative Research in Science, Engineering and Technology

(An ISO 3297: 2007 Certified Organization)

Website: www.ijirset.com

Vol. 6, Issue 6, June 2017

B. Organization Of The Paper:

The paper is organized as follows: Section III includes Methodology which includes outline of the proposed work, Section IV includes Experimental Results, Section V includes Performance and Section VI includes Conclusion.

III. METHODOLOGY

C. Outline Of The Proposed Work:

We take an MRI liver image as an input image and add noises namely gaussian noise, salt and pepper noise, and speckle noise with different noise variance ranging from (0.01-0.08). The input image is transformed in to 2D DWT and the image is decomposed into 4 sub-bands namely LL, LH, HL, HH using different wavelets iteratively using Haar, Daubechies, Biorthogonal, Coiflet, and Symlet. The decomposed image is denoised using mean and median filters. Then we reconstruct the denoised image by using the inverse wavelet transform. The performance quality is measured by metrics PSNR, MSE and Accuracy and then the results are compared.

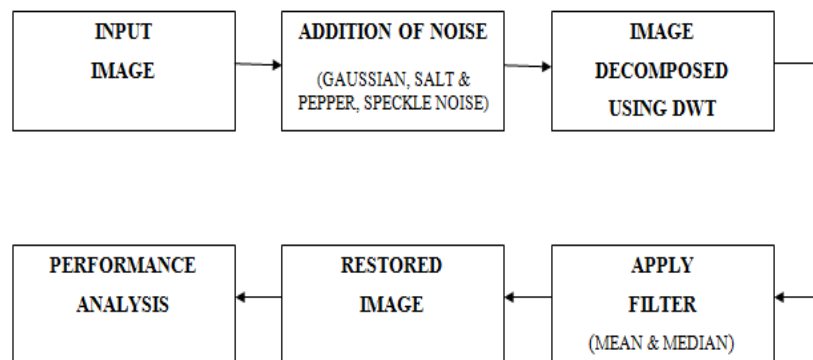

Fig.1 Image denoising block diagram for DWT

D. Discrete Wavelet Transform:

Discrete wavelet transform (DWT) uses the scale parameter as well as the shifting parameter for wavelet transformation. The scale parameter either expands or compresses the width of a wavelet function while maintaining its basic structure. The larger a scale value becomes, the greater the width becomes, presenting the features of a low-frequency component. In contrast, the smaller a scale value becomes, the greater the features of a high-frequency component. The shifting parameter determines the position of functions along the time axis. As the value of shifting parameters become larger, the functions move to the right in parallel.

The discrete wavelet transform is used for image noise removal. It will perform the sub band decomposition. This decomposition is done by row and column wise processing the image. Wavelet splits the image into 4 sub bands such as LL, LH, HL, HH. The LL image contains the low frequency components while LH, HL and HH contains high frequency components in horizontal, vertical and diagonal directions respectively. Approximation part is LL, and the other part is detailed part. The sub-band LL which is the approximation of digital image is further decomposed by discrete wavelet transform to get any level of decomposition of the digital content and it will generate the further four sub-bands. Thus the information of image is stored in decomposed form in these sub-bands.

International Journal of Innovative Research in Science, Engineering and Technology

(An ISO 3297: 2007 Certified Organization)

Website: www.ijirset.com

Vol. 6, Issue 6, June 2017

LL1	HL1
LH1	HH1

Fig.2 Decomposition of image at Level 1

E. Wavelet families:

1. Haar wavelet:

The Haar wavelet is a simple possible wavelet. This wavelet transform may be considered to pair up input values, store the difference and passing the sum. This process is repeated again and again paring up the sums to provide the next scale, finally resulting in the differences of one final sum.

2. Daubechies wavelet:

The Daubechies wavelet based on the work of Ingrid Daubechies, are a family of orthogonal wavelets defining a discrete wavelet transform. These wavelet bases are a family of orthonormal, compactly supported scaling and wavelet functions that have maximum regularity for a given length of the support of the quadrature mirror filters. Daubechies has shown that it is impossible to obtain an orthonormal and compactly supported wavelet that is either symmetric or antisymmetric except for Haar wavelets.

3. Symlet wavelet:

Symlet wavelets are a family of wavelets which are nearly symmetrical wavelets proposed by Daubechies as modification to the db family. The properties of the two wavelet families are similar. There are 7 different symlet functions from sym2 to sym8. In symN, N is the order.

4. Coiflet wavelet:

Coiflets are discrete wavelets which have scaling functions with vanishing moments. The wavelet is near symmetric, their wavelet functions has 2N moments equal to 0 and scaling functions has 2N-1 moments equal to 0. The two functions have a support of length 6N-1.

5. Biorthogonal wavelet:

A biorthogonal wavelet is a wavelet where the associated wavelet transform is invertible but not necessarily orthogonal. Designing biorthogonal wavelets allows more degrees of freedom than orthogonal wavelets. One additional degree of freedom is the possibility to construct symmetric wavelet functions.

In the biorthogonal case, there are two scaling functions $\phi, \tilde{\phi}$ which may generate different multiresolution analyses, and accordingly two different wavelet functions $\psi, \tilde{\psi}$. So the numbers M and N of coefficients in the scaling sequences a, \tilde{a} may differ. The scaling sequences must satisfy the following biorthogonality condition

International Journal of Innovative Research in Science, Engineering and Technology

(An ISO 3297: 2007 Certified Organization)

Website: www.ijirset.com

Vol. 6, Issue 6, June 2017

$$\sum_{n \in \mathbb{Z}} a_n \tilde{a}_{n+2m} = 2 \cdot \delta_{m,0}.$$

Then the wavelet can be determined as

$$b_n = (-1)^n \tilde{a}_{M-1-n} \quad (n = 0, \dots, N-1)$$

$$\tilde{b}_n = (-1)^n a_{M-1-n} \quad (n = 0, \dots, N-1).$$

IV. EXPERIMENTAL RESULTS

Experiments were conducted to remove noise in an MRI liver image shown in Fig.3. To the original image Gaussian Noise, Salt & Pepper noise and speckle noise are added. Then the image is decomposed by using wavelet bases at level 1 and filters are applied and the results are given in Fig.4.

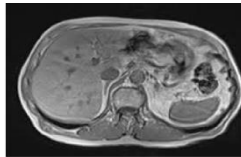

Fig.3 Input image











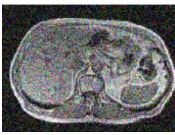
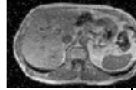











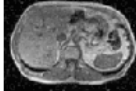

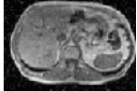

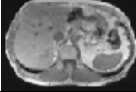
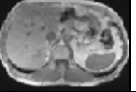
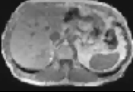
Noise	Noisy image	Filter	Wavelet type				
			Haar	DB4	Symlet	Coiflet	Biorthogonal
Gaussian		Mean					
		Median					
Salt & Pepper		Mean					
		Median					
Speckle		Mean					
		Median					

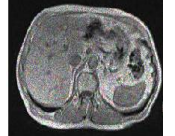
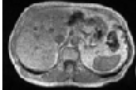
Fig 4. Wavelet bases and denoised image

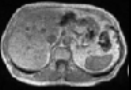
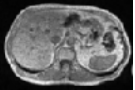
International Journal of Innovative Research in Science, Engineering and Technology

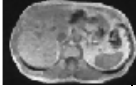
(An ISO 3297: 2007 Certified Organization)

Website: www.ijirset.com

Vol. 6, Issue 6, June 2017

V. PERFORMANCE METRICS

A. MSE (Mean Squared Error):

It is the mean squared difference between the original image and the degraded image. The error is the amount by which the value obscure by the estimator differs from the quantity to be estimated. The image quality parameters used in this work for comparing the denoised result with the original image. It is expressed as

$$MSE = \frac{1}{MN} \sum_{x=0}^{M-1} \sum_{y=0}^{N-1} [f(x,y) - \hat{f}(x,y)]^2$$

B. PSNR (Peak Signal to noise ratio):

It is a classical index defined as the ratio between the maximum possible power of a signal and the power of corrupting noise that affects the fidelity of its representation.

$$PSNR = 10 * \log_{10} \left(\frac{255^2}{MSE_{min}} \right)$$

Where 255 is the maximal possible pixel value, when pixels are represented using 8 bits per sample, and MSE (Mean Square Error) is the Euclidean distance between the original and degraded image.

C. Accuracy:

It is a measure close to the actual value. It is the proportion of true results.

$$Accuracy = \frac{TP + TN}{TP + TN + FP + FN}$$

D. Performance Evaluation:

In evaluating the performance different wavelet bases and filtering techniques were presented. Performance is calculated by PSNR, MSE, and ACCURACY. DB4 perform well. In Table 1 different wavelet bases and metrics are presented.

Table 1: Wavelet Bases vs Metric

Metrics	Wavelet Bases	Gaussian	salt & Pepper	Speckle	Gaussian	salt & Pepper	Speckle
		Mean	Mean	Mean	Median	Median	Median
PSNR	Haar	53.21037	52.82252	52.39438	53.12865	52.78436	52.49167
	DB4	62.62691	54.986	52.78453	62.60472	64.09342	52.86007
	Sym	59.0963	55.86714	52.67029	59.35303	55.13168	52.89225
	Coif	55.52011	54.36442	52.1283	55.72338	53.35303	52.16067
	Bior	53.6406	53.57081	52.43908	53.79016	52.74139	52.42517
MSE	Haar	0.312783	0.339835	0.374672	0.318494	0.342493	0.366366
	DB4	0.053662	0.214776	0.342477	0.041623	0.025392	0.336576
	Sym	0.105284	0.186853	0.351606	0.090476	0.20511	0.33414
	Coif	0.206059	0.254232	0.398339	0.200364	0.308622	0.39538
	Bior	0.28823	0.290318	0.370843	0.274102	0.346338	0.37203
ACC	Haar	68.72172	66.01645	62.53283	68.15061	65.75067	63.36339
	DB4	94.63376	78.52239	65.75225	95.83768	97.46084	66.34235
	Sym	89.4716	81.31467	64.83942	90.95238	79.489	66.58598
	Coif	79.39408	74.57681	60.16611	79.96361	69.13779	60.46195
	Bior	71.17703	70.9682	62.91568	72.58978	65.36624	62.79703

International Journal of Innovative Research in Science, Engineering and Technology

(An ISO 3297: 2007 Certified Organization)

Website: www.ijirset.com

Vol. 6, Issue 6, June 2017

By varying the noise levels from 0.01 to 0.08 and by using mean filter for various noises, results are taken and shown in Table 2. The result concluded from table 2 is Gaussian noise with symlet shows the better result using mean filter.

Table 2: Noise Variance Vs Mean Filter

Noise variance	Salt & pepper noise for haar with mean filter			Gaussian noise for haar with mean filter			Speckle noise for haar with mean filter		
	ACC	MSE	PSNR	ACC	MSE	PSNR	ACC	MSE	PSNR
0.01	64.56257	0.354374	52.63618	64.63376	0.353662	52.64491	62.35564	0.376444	52.3738
0.02	65.01345	0.349866	52.69179	65.64626	0.343537	52.77106	62.15789	0.378421	52.35105
0.04	65.51179	0.344882	52.7541	67.41022	0.325898	52.99999	62.65623	0.373438	52.40862
0.06	66.16042	0.338396	52.83655	71.38902	0.28611	53.56548	62.76697	0.37233	52.42152
0.08	68.83405	0.31166	53.194	74.52935	0.254707	54.0704	62.72742	0.372726	52.41691
Noise variance	Salt & pepper noise for DB4 with mean filter			Gaussian noise for DB4 with mean filter			Speckle noise for DB4 with mean filter		
	ACC	MSE	PSNR	ACC	MSE	PSNR	ACC	MSE	PSNR
0.01	71.15963	0.288404	53.53079	84.43284	0.155672	56.20871	65.61462	0.343854	52.76707
0.02	74.4186	0.255814	54.05156	94.62901	0.05371	60.83026	65.53552	0.344645	52.75709
0.04	78.04145	0.219586	54.71477	95.23145	0.027685	63.70828	65.90729	0.340927	52.80419
0.06	81.37162	0.186284	55.42905	96.41797	0.01582	66.13866	65.89938	0.341006	52.80318
0.08	87.62063	0.123794	57.20382	96.45752	0.015425	66.24862	65.80446	0.341955	52.79111
Noise variance	Salt & pepper noise for symlet with mean filter			Gaussian noise for symlet with mean filter			Speckle noise for symlet with mean filter		
	ACC	MSE	PSNR	ACC	MSE	PSNR	ACC	MSE	PSNR
0.01	69.22955	0.307704	53.24947	75.69214	0.243079	54.27334	64.61794	0.353821	52.64297
0.02	74.60845	0.253916	54.08391	86.47366	0.135263	56.819	64.77614	0.352239	52.66243
0.04	83.70511	0.162949	56.01029	92.65939	0.073406	59.47348	64.95017	0.350498	52.68394
0.06	87.63645	0.123636	57.20937	95.7127	0.042873	61.80897	64.76823	0.352318	52.66146
0.08	91.39377	0.086062	58.78267	96.82012	0.031799	63.1067	65.08464	0.349154	52.70064
Noise variance	Salt & pepper noise for coiflet with mean filter			Gaussian noise for coiflet with mean filter			Speckle noise for coiflet with mean filter		
	ACC	MSE	PSNR	ACC	MSE	PSNR	ACC	MSE	PSNR
0.01	62.276539	0.3772346	52.364688	62.9489	0.370511	52.442793	60.006328	0.3999367	52.110891
0.02	66.405632	0.3359437	52.868139	73.398196	0.266018	53.881693	60.13289	0.3986711	52.124656
0.04	76.649264	0.2335074	54.447798	82.170543	0.1782946	55.619422	60.227812	0.3977219	52.135009
0.06	81.545642	0.1845436	55.469814	88.166429	0.1183357	57.399646	60.393925	0.3960607	52.153186
0.08	86.006961	0.1399304	56.671683	90.286347	0.0971365	58.256978	60.069609	0.3993039	52.117768
Noise variance	Salt & pepper noise for biorthogonal with mean filter			Gaussian noise for biorthogonal with mean filter			Speckle noise for biorthogonal with mean filter		
	ACC	MSE	PSNR	ACC	MSE	PSNR	ACC	MSE	PSNR
0.01	67.560513	0.3243949	53.020064	65.456415	0.3454358	52.74713	62.37937	0.3762063	52.376543
0.02	70.637557	0.2936244	53.452882	64.388546	0.3561145	52.614907	63.083373	0.3691663	52.458583
0.04	64.174972	0.3582503	52.588938	73.03433	0.2696567	53.822691	62.656225	0.3734377	52.408621
0.06	73.698782	0.2630122	53.931045	71.808258	0.2819174	53.629585	63.249486	0.3675051	52.478169
0.08	78.769182	0.2123082	54.861136	81.197595	0.188024	55.38867	63.209935	0.3679006	52.473498

International Journal of Innovative Research in Science, Engineering and Technology

(An ISO 3297: 2007 Certified Organization)

Website: www.ijirset.com

Vol. 6, Issue 6, June 2017

By varying the noise levels from 0.01 to 0.08 and by using median filter for various noises, results are taken and shown in Table 3. The result concluded from table 3 is salt and pepper noise with DB4 shows the better result using median filter.

Table 3: Noise Variance Vs Median Filter

Noise variance	Salt & pepper noise for haar with median filter			Gaussian noise for haar with median filter			Speckle noise for haar with median filter		
	ACC	MSE	PSNR	ACC	MSE	PSNR	ACC	MSE	PSNR
0.01	65.49597	0.34504	52.7521	64.63376	0.353662	52.64491	63.46306	0.365369	52.50348
0.02	65.59089	0.344091	52.76407	65.03718	0.349628	52.69474	63.16247	0.368375	52.4679
0.04	65.74909	0.342509	52.78408	66.71413	0.332859	52.9082	63.48679	0.365132	52.5063
0.06	65.82819	0.341718	52.79412	70.31324	0.296868	53.40518	63.31277	0.366872	52.48565
0.08	66.08923	0.339108	52.82743	74.05474	0.259453	53.99022	63.39187	0.366081	52.49503
Noise variance	Salt & pepper noise for DB4 with median filter			Gaussian noise for DB4 with median filter			Speckle noise for DB4 with median filter		
	ACC	MSE	PSNR	ACC	MSE	PSNR	ACC	MSE	PSNR
0.01	97.63487	0.023651	64.39225	91.74181	0.082582	58.96196	66.23952	0.337605	52.84672
0.02	97.5004	0.024996	64.15209	94.65274	0.053473	60.84949	66.12878	0.338712	52.83249
0.04	97.60323	0.023968	64.33454	95.97833	0.030217	63.32833	66.32653	0.336735	52.85792
0.06	97.40547	0.025945	63.99022	95.72188	0.022781	64.55504	66.23161	0.337684	52.8457
0.08	97.16026	0.028397	63.59802	95.09366	0.019063	65.32879	66.78532	0.332147	52.9175
Noise variance	Salt & pepper noise for symlet with median filter			Gaussian noise for symlet with median filter			Speckle noise for symlet with median filter		
	ACC	MSE	PSNR	ACC	MSE	PSNR	ACC	MSE	PSNR
0.01	74.14175	0.258583	54.00481	82.32875	0.176713	55.65813	66.16833	0.338317	52.83757
0.02	75.25708	0.247429	54.19629	87.50198	0.12498	57.16239	66.84069	0.331593	52.92475
0.04	78.24711	0.217529	54.75563	92.84132	0.071587	59.58248	65.64626	0.343537	52.77106
0.06	83.87913	0.161209	56.05692	95.64942	0.043506	61.74533	67.42604	0.32574	53.0021
0.08	85.91995	0.140801	56.64476	96.44044	0.035596	62.61684	66.8486	0.331514	52.92578
Noise variance	Salt & pepper noise for coiflet with median filter			Gaussian noise for coiflet with median filter			Speckle noise for coiflet with median filter		
	ACC	MSE	PSNR	ACC	MSE	PSNR	ACC	MSE	PSNR
0.01	61.50925	0.384907	52.27724	66.09714	0.339029	52.82844	60.43348	0.395665	52.15752
0.02	63.24949	0.367505	52.47817	70.77994	0.292201	53.47399	60.47303	0.39527	52.16187
0.04	68.05094	0.319491	53.08622	83.28587	0.167141	55.89997	60.36228	0.396377	52.14972
0.06	72.78912	0.272109	53.78338	87.19348	0.128065	57.05649	60.3781	0.396219	52.15145
0.08	80.09018	0.199098	55.14013	92.46164	0.075384	59.35803	60.66287	0.393371	52.18278
Noise variance	Salt & pepper noise for biorthogonal with median filter			Gaussian noise for biorthogonal with median filter			Speckle noise for biorthogonal with median filter		
	ACC	MSE	PSNR	ACC	MSE	PSNR	ACC	MSE	PSNR

International Journal of Innovative Research in Science, Engineering and Technology

(An ISO 3297: 2007 Certified Organization)

Website: www.ijirset.com

Vol. 6, Issue 6, June 2017

0.01	63.66081	0.363392	52.52705	66.37399	0.33626	52.86405	63.15456	0.368454	52.46697
0.02	63.92185	0.360782	52.55836	70.49517	0.295048	53.43187	62.98054	0.370195	52.4465
0.04	64.68122	0.353188	52.65075	74.22085	0.257791	54.01812	62.85398	0.37146	52.43168
0.06	66.23161	0.337684	52.8457	75.12261	0.248774	54.17275	62.26863	0.377314	52.36378
0.08	68.33571	0.316643	53.12511	76.73628	0.232637	54.46401	62.72742	0.372726	52.41691

VI. CONCLUSION

In this paper, we present an analysis of denoising an MRI liver image using discrete wavelet transform and various filters. DWT is a good tool for image denoising. Filtering techniques are used to increase the image clarity. Experiments were conducted to study the suitability of different wavelet bases like Haar, Daubechies, Coiflet, symlet, Biorthogonal. Qualitative performance measure such as PSNR, MSE, and Accuracy were used to analyse the denoising effect. In DWT, DB4 performed well against salt and pepper noise with median filter. In future, work can be done to implement on other types of medical imaging like CT scan, Ultrasound, and EEG images under different kinds of wavelets.

REFERENCES

1. Pawan Patidar, Manoj Gupta, Sumit Srivastava, and Ashok Kumar Nagawat, "Image De-noising by Various Filters for Different Noise", International Journal of Computer Applications, Volume 9, No. 4, 2010 November.
2. Taruna Grover, "Denoising Of Medical Images Using Wavelet Transform", Imperial Journal of Interdisciplinary Research, Volume 2, Issue 3, 2016.
3. Rohit Verma, and Jahid Ali, "A Comparative Study of Various Types of Image Noise and Efficient Noise Removal Techniques", International Journal of Advanced Research in Computer Science and Software Engineering, Volume 3, Issue 10, 2013 October.
4. S.Kother Mohideen, Dr.S.Arumba Perumal, and Dr.M.Mohamed Sathik, "Image De-noising using Discrete Wavelet Transform", International Journal of Computer Science and Network Security, Volume 8, No. 1, 2008 January.
5. Kanwaljot Singh Sidhu, Baljeet Singh Khaira, and Ishpreet Singh Virk, "Medical Image Denoising In The Wavelet Domain Using Haar and DB3 Filtering", International Refereed Journal of Engineering and Science, Volume 1, Issue 1, 2012 September.
6. Grace Chang, S., Bin Yu, and Martin Vetterli, "Adaptive Wavelet Thresholding for Image Denoising and Compression", IEEE Transactions on Image Processing, Volume 9, No 9, 2000 September.
7. Neelima M. and Md. Mahaboob Pasha, "Wavelet Transform Based On Image Denoising Using Threshold Techniques", International Journal of Advanced Research in Computer and Communication Engineering, Volume 3, Issue 9, 2014 September.
8. E. Jebamalar Leavline and Asir Antony Gnana Singh D., "Salt and Pepper Noise Detection and Removal in Gray Scale Images: An Experimental Analysis", International Journal of Signal Processing, Image Processing and Pattern Recognition, Volume 6, No 5, 2013.
9. Mannika Chhabra and Sarita Bajaj, "Image Denoising Using DWT Hybrid Thresholding and Intensity Transform", International Journal of Computer Application, Volume 4, Issue 4, 2014 July-August.
10. Taranjot Kaur, "Image Denoising Algorithms and DWT: A Review", International Journal of Computer Science and Information Technologies, Volume 5 (5), 2014.
11. Maheswari et. al D., "Noise Removal in Compound Image Using Median Filter", International Journal on Computer Science and Engineering", Volume 2, No 4, 2010.
12. Gonzalez R. C. and Woods R. E, "Digital Image Processing (2nd Edition), Pearson Publications, 2002.
13. Fathimathu Joharah S. and Shajun Nisha S., "Denoising MRI Liver Image Using DWT", International Journal of Trend in Research and Development, Volume 4(1), Jan-Feb 2016.
14. Renjini L and Jyothi R L, "Wavelet Based Image Analysis:A Comprehensive Survey", International Journal of Computer Trends and Technology, Volume 21, No 3, Mar 2015.
15. Vijayalakshmi. A, Titus.C , and Lilly Beaulah.H, "Image Denoising for different noise models by various filters: A Brief Survey", International Journal of Emerging Trends & Technology in Computer Science, Volume 3, 2014.
16. Meenakshi Chaudhary and Anupma Dhamija, "A brief study of various wavelet families and compression techniques", Journal of Global Research in Computer Science, April 2013.
17. Cheng Chen and Ningning Zhou, "A new wavelet hard threshold to process image with strong Gaussian Noise", Advanced Computational Intelligence, 2012.
18. Priyanka Singh, Priti Singh, and Rakesh Kumar Sharma, "JPEG Image Compression based on Biorthogonal, Coiflets and Daubechies Wavelet Families", International Journal of Computer Applications, Volume 13, No 1, January 2011.
19. Latha Rani G.L, Jannath Firthouse P, and Shajun Nisha S, "A Study on Medical Image Denoising using Wavelet and Contourlet Transform", International Journal of Advanced Research in Computer Science and Management Studies, Volume 4, Issue 3, March 2016.
20. Joharah S, Shajun Nisha S, and Mohamed Sathik M, "Noise Reduction in MRI Liver Image Using Discrete Wavelet Transform", International Research Journal Of Engineering And Technology, Volume 4, Issue 3, March 2017.